

SL 280 INDOOR

Technical specifications

Lifting cap. arm in/out	280/160kg - 620/350lb
Lifting height	2750mm / 108in
Extension of arm	500mm / 20in
Tilt	49° back / 104° fwd
Side shift	100mm / 4in
Charging voltage	230V / 110V
Charging time	Approx. 8 hrs
Running period	Up to 10 hrs
Rear-wheel drive	700W
Width	630mm / 25in
Suction pads	4 x Ø300mm / 4 x Ø12in
Curb weight	490kg / 1080lb

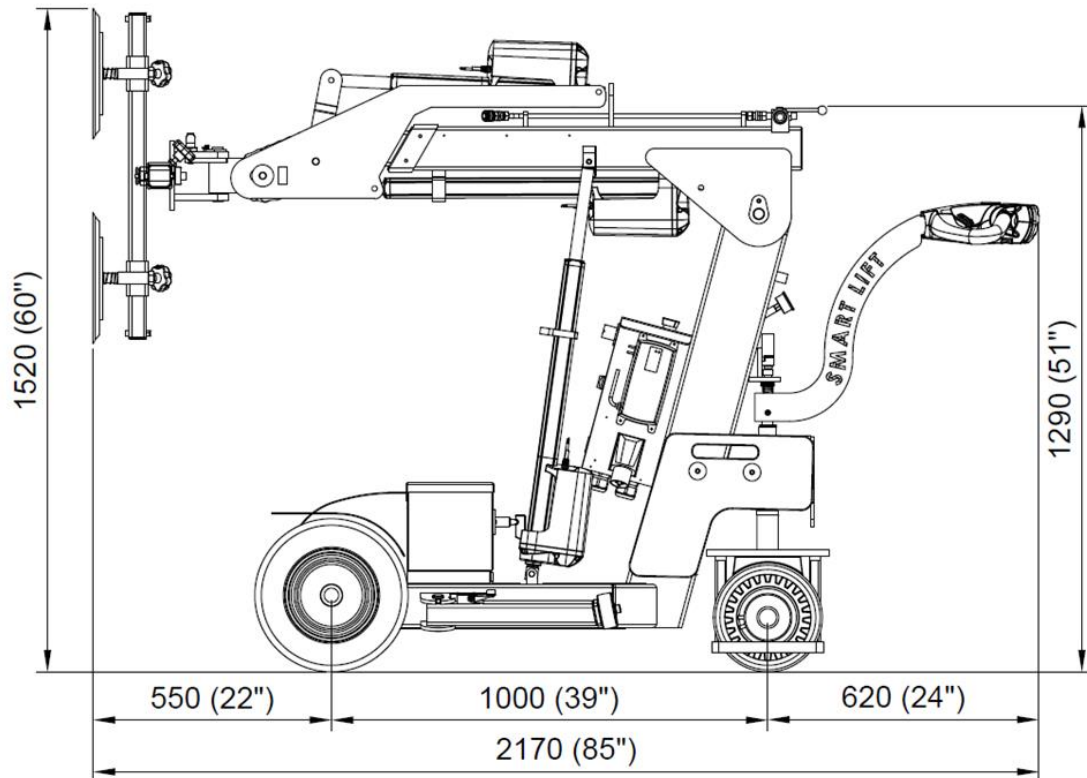
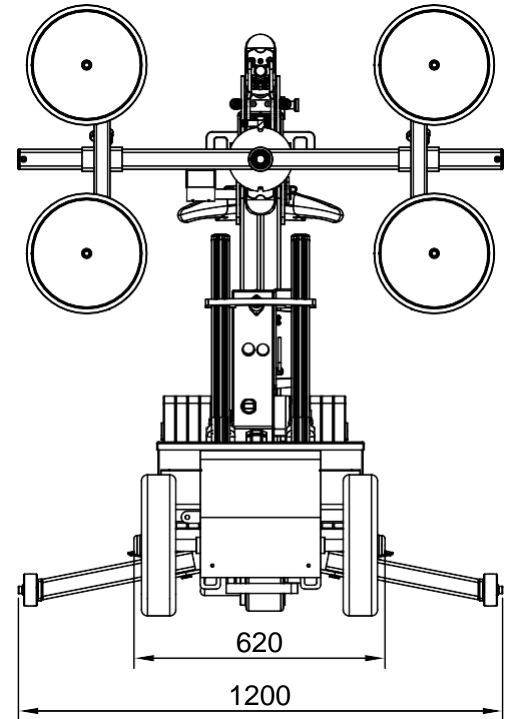

Load chart

